

SF 10 D/ID LED

HOUSING

THE 2 INCHES DEEP HSG TO BE FORMED FROM 20GA CRS. FINISH BAKED WHITE ENAMEL(STANDARD). ALL FIXTURES ARE PRE-WIRED. ALL STEEL PARTS ARE PHOSPHATE TREATED FOR CORROSION RESISTANCE BEFORE PAINT PROCEDURE THEN BAKED WITH SUPERIOR ADHESION FOR DURABILITY.

LED MODULES

HIGHER EFFICACY UP TO 170 LPW WITH SERVICE LIFE GREATER THAN 60000(L70) HIGH COLOR RENDER AND EXCELLENT COLOR CONSISTENCY COLOR OPTIONS AVAILABLE FROM 27K TO 40K . 90 CRI LEDS AVAILABLE AS OPTIONAL

DRIVERS

CONSTANT CURRENT, CLASS 2
UNIVERSAL INPUT : 120-277VAC
SOUND RATED A, 54V OUTPUT 0-10V
DIMMING STANDARD .
DALI, ECOSYSTEM AND DMX DRIVERS ALSO AVAILABLE

REFLECTOR

TO BE FORMED FROM 20GA CRS
FINISH: BAKED WHITE ENAMEL WITH
90% REFLECTIVITY

MOUNTING

AIRCRAFT CABLE, PENDANT OR
WALL MOUNTED



PRODUCT DESCRIPTION

THE SF10 LED SERIES IS A LOW PROFILE FIXTURE WITH DIRECT/INDIRECT LIGHTING DISTRIBUTION IDEAL FOR OPEN OFFICES, CONFERENCE ROOMS, AND PUBLIC AREAS. **THE RECTILINEAR DESIGN FITS IDEALLY INTO WIDE AND BROAD CONTEMPORARY OPEN OFFICES, CLASSROOMS OR LABORATORY SPACES. THE APERTURE OF THE FIXTURE PROVIDES MORE OF A DIRECT LIGHT COMPONENT THAN OTHER COMPANION PIECES IN THE NATIONAL PRODUCT LINE. THE LEDS AND DIMMING DRIVERS CAN PROVIDE HIGHER OR LOWER LUMENS AS REQUIRED. THE WIDE HORIZONTAL DISTRIBUTION OF THE LEDS RESULTS IN UNPARALLELED SPACING.** OPTICAL WHITE DIFFUSERS ENHANCES THE FIXTURE DESIGN. 60000 HOURS OF LIFE AND EXCELLENT COLOR RENDITION ARE PRODUCTS OF THE CUTTING EDGE LED SYSTEM.

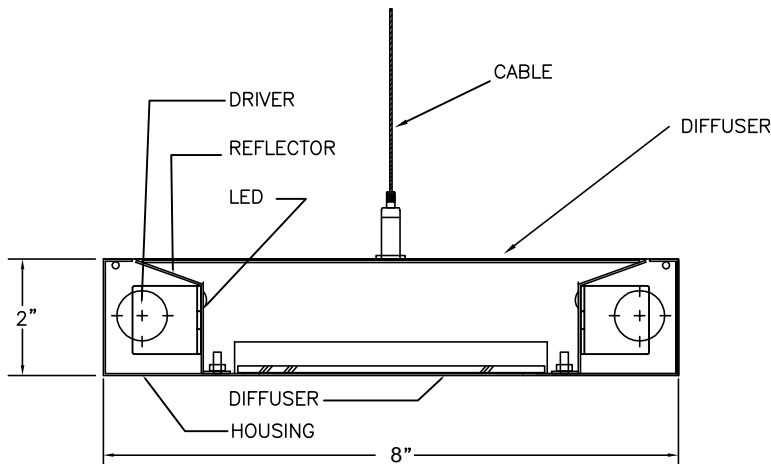

TYPE: _____

PROJECT: _____

EVEN AND VISUALLY
COMFORTABLE LED
LIGHT DISTRIBUTION
ACROSS PROFILE OF
THE PRODUCT

50% ENERGY
SAVINGS COMPARED
TO LINEAR
FLUORESCENT

SUSTAINABLE
MATERIALS

ARRAY OF LUMEN
OPTIONS ALL
LM79/LM80 UL
APPROVED

5 YEAR WARRANTY
LED AND DRIVER

ORDERING KEY

SERIES	LUMENS (W/ft)	LENGTH	COLOR TEMP	MOUNTING	VOLTAGE	OPTIONS
SF10D/ID LED	<input type="checkbox"/> LO 950(11W/ft) <input type="checkbox"/> MC 1050(12.75W/ft) <input type="checkbox"/> HC 1300(15W/ft) Please contact National for other options.	<input type="checkbox"/> 4' <input type="checkbox"/> 8' <input type="checkbox"/> ROWS	<input type="checkbox"/> 2700K <input type="checkbox"/> 3000K <input type="checkbox"/> 3500K <input type="checkbox"/> 4000K <input type="checkbox"/> 5000K	<input type="checkbox"/> AC - CABLE <input type="checkbox"/> P - STEM <input type="checkbox"/> WM - WALL <input type="checkbox"/> 24" <input type="checkbox"/> 48" <input type="checkbox"/> OTHER _____	<input type="checkbox"/> 120 V <input type="checkbox"/> 277 V <input type="checkbox"/> UNIVERSAL	<input type="checkbox"/> EM <input type="checkbox"/> DIM 0-10 <input type="checkbox"/> DALI <input type="checkbox"/> LUTRON, ECOSYS <input type="checkbox"/> LUTRON -3 WIRE <input type="checkbox"/> LUTRON 2-WIRE/AC

LUMENS WILL VARY
DEPENDING ON DIFFUSER
AND LED COLOR TEMP

NATIONAL 3E/LED SERIES USES ENGINE/STICK ORIGINAL EQUIPMENT (BY OSRAM, PHILIPS, SAMSUNG, ET AL) WHICH ARE RATED FOR APPROXIMATELY 100 LM/W. ARCHITECTURAL LENSES PROVIDED WITH THE LUMINAIRES BY DESIGN EVEN THE BRIGHTNESS AND VISUAL COMFORT AND MIGHT FRACTIONALLY LOWER LM/W.



522 CORTLANDT ST.
BELLEVILLE, NJ 07109

NJ 973-751-1600
NY 212-751-1600
FAX 973-751-4931
WWW.NATLTG.COM

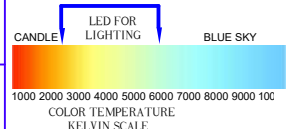

PHOTOMETRIC DATA

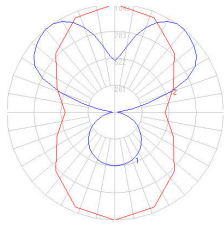

LIFE: 60,000 HRS
WATTS:33
LUMENS:3689
EFFICACY:112
CRI: 80+

ID70/ D30

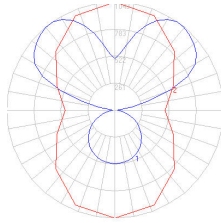

LIFE: 60,000 HRS
WATTS:45
LUMENS:5589
EFFICACY:124
CRI: 80+

ID70/ D30

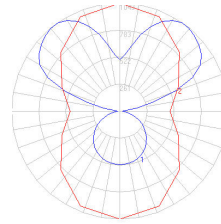

LIFE: 60,000 HRS
WATTS:52
LUMENS:6148
EFFICACY:118
CRI: 80+

ID70/ D30

VALUES ARE BASED ON 4' SECTION FOR OTHER DISTRIBUTION LIKE 80ID/20D AND 60ID/D40 PLEASE CONTACT NATIONAL.

MOUNTING INSTRUCTIONS

TYPICAL 16' RUN

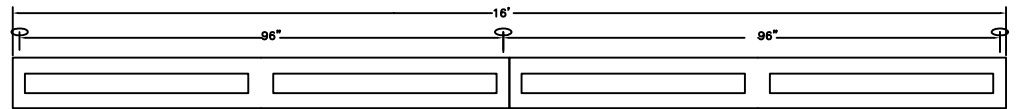

8'BOR

8'EOR

TYPICAL 8' IND

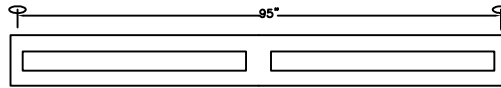

8'BOR

TYPICAL 4' IND

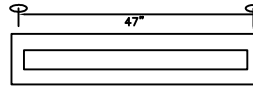

AIRCRAFT CABLE MOUNTING ASSEMBLY WITH POWER CORD

NOTE:
ABOVE STRUCTURAL SUPPORT FOR
JUNCTION BOX SUPPLIED BY OTHERS

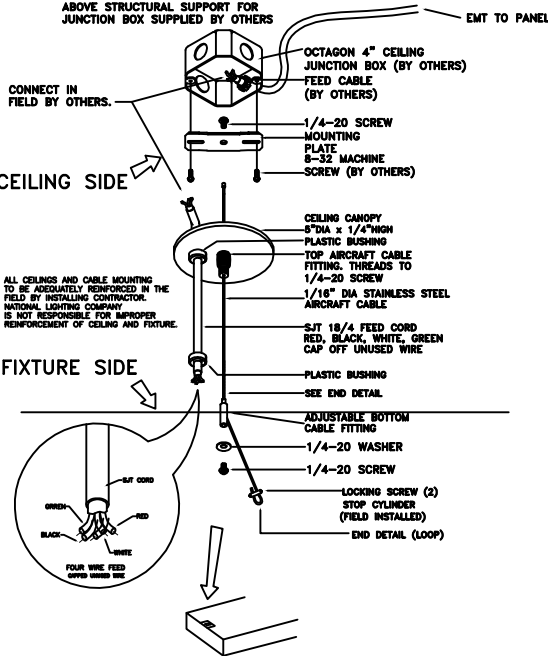

ALL CEILINGS AND CABLE MOUNTING TO BE ADEQUATELY REINFORCED IN THE FIELD BY INSTALLING CONTRACTOR. NATIONAL LIGHTING COMPANY IS NOT RESPONSIBLE FOR IMPROPER REINFORCEMENT OF CEILING AND FIXTURE.

LIGHTING CONTROL SOLUTIONS

1. DIMMING (0-10V, DALI Or Lutron)
 - 0-10V Dimming Driver used as standard.
 - Continuous Dimming up to 10%.
 - Dimming wires not provided unless specified
 - Contact National for Dali or Lutron Control system
2. Occ/DAYLIGHT/Vacancy/Bi-Level
 - Sensor-ready and compatible drivers provided.
 - Sensors can be field installed or could be installed in the fixtures
 - Bi-level dimming and Motion sensors also available
3. Compatibility:
 - National fixtures are compatible with Lutron, Philips Actilume, Magnum, Wattstopper, Hubbell , Leviton , Hytronik , Daintree & Enlighted Control System

CORNER DETAIL

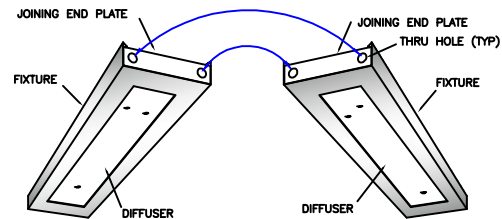

NOTE: CHASE NIPPLE SUPPLIED BY OTHERS FOR THRU HOLES AS SHOWN. IT IS INCUMBENT UPON FOR THE CONTRACTOR TO FIELD ALIGNED UNITS.



NATIONAL LIGHTING COMPANY, INC.
522 CORTLANDT ST.
BELLEVILLE, NJ 07109

NJ 973-751-1600
NY 212-751-1600
FAX 973-751-4931
WWW.NATLTG.COM

JOB NAME:	
CATALOG:	
TYPE:	