

OBLIQUE 2x2 LED

HOUSING

TO BE FORMED FROM 20GA CRS.
FINISH: BAKED WHITE ENAMEL (STANDARD)
ALL FIXTURES ARE PRE-WIRED.
ALL STEEL PARTS ARE PHOSPHATE
TREATED FOR CORROSION RESISTANCE
BEFORE PAINT PROCEDURE, THEN
BAKED WITH SUPERIOR ADHESION FOR
DURABILITY.

LED MODULES

MID POWER FR4 LED
(INSTALLED 3000K-4000K)
2 LIGHT CROSS SECTION ARRAY

DRIVERS

LED ELECTRONIC DRIVER 30W-75W
VOLTAGE: 120V-277V (UNIVERSAL)
CLASS 2
UL AND ROHS COMPLIANCE

REFLECTOR

TO BE FORMED FROM 20GA. CR.S.
FINISH: BAKED WHITE ENAMEL
WITH 89% REFLECTIVITY

MOUNTING

FLANGE, SLOT GRID,
GRID (T), 9/16"GRID (T1)



PRODUCT DESCRIPTION

THE OBLIQUE 2'X2' LED DELIVERS AESTHETICS, AND DIGITAL LED LIGHTING. THE EXCELLENT PERFORMANCE OF THE OPTICAL SYSTEM IS IDEAL FOR CLASS ROOMS, LARGE AND SMALL OFFICES AND HEALTH CARE FACILITIES. THE FROSTED LINEAR PRISMS ARE INTEGRAL TO THE EXTRUDED ACRYLIC DIFFUSER. IN COMBINATION WITH THE OPTICAL SYSTEM LIGHT IS DISTRIBUTED EVENLY INTO THE SPACE.

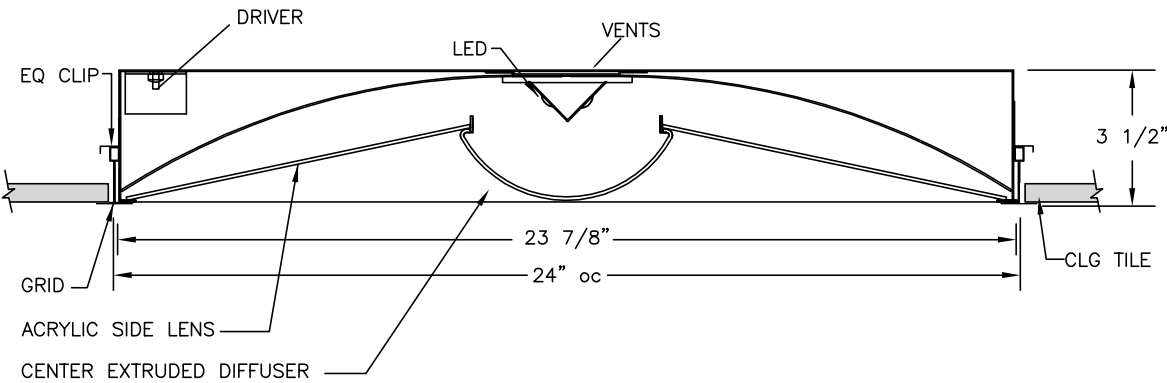

TYPE:

PROJECT:

EVEN AND VISUALLY
COMFORTABLE LED
LIGHT DISTRIBUTION
ACROSS PROFILE OF
THE PRODUCT

50% ENERGY
SAVINGS COMPARED
TO LINEAR
FLUORESCENT

SUSTAINABLE
MATERIALS

ARRAY OF LUMEN
OPTIONS ALL
LM79/LM80 UL
APPROVED

5 YEAR WARRANTY
LED AND DRIVER

CEILING OPTIONS

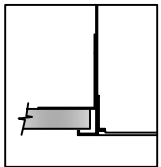

FLANGE(F)

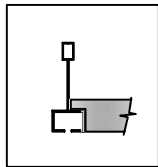

SLOT GRID(SG)

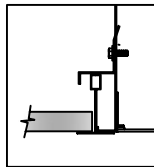

GRID (T)

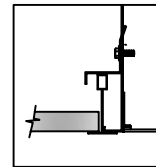

9/16"GRID (T1)

ORDERING KEY

SERIES	LUMENS / (W)	COLOR TEMP	CEILING TYPE	VOLTAGE	OPTIONS
OBLQ 2X2 LED	<input type="checkbox"/> LO 2259 (23W) <input type="checkbox"/> MO 35 (3623W) <input type="checkbox"/> HO 4262 (41W)	<input type="checkbox"/> 2700K <input type="checkbox"/> 3000K <input type="checkbox"/> 3500K <input type="checkbox"/> 4000K <input type="checkbox"/> 5000K	<input type="checkbox"/> T <input type="checkbox"/> F <input type="checkbox"/> SG <input type="checkbox"/> T1	<input type="checkbox"/> 120 V <input type="checkbox"/> 277 V <input type="checkbox"/> UNIVERSAL	<input type="checkbox"/> EM <input type="checkbox"/> DIM 0-10 <input type="checkbox"/> DALI <input type="checkbox"/> LDE1 - Eco1% <input type="checkbox"/> L3DA-3Wire or Eco1% <input type="checkbox"/> SENSOR(OCC/VAC) <input type="checkbox"/> TAILS

LUMENS WILL VARY
DEPENDING ON DIFFUSER
AND LED COLOR TEMP.

NATIONAL 3E/LED SERIES USES ENGINE/STICK ORIGINAL EQUIPMENT (BY OSRAM, PHILIPS, SAMSUNG, ET AL) WHICH ARE RATED FOR APPROXIMATELY 100 LMWT. ARCHITECTURAL LENSES PROVIDED WITH THE LUMINAIRES BY DESIGN EVEN THE BRIGHTNESS AND VISUAL COMFORT AND MIGHT FRACTIONALLY LOWER LMWT.

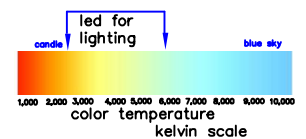

522 CORTLANDT ST.
BELLEVILLE, NJ 07109

NJ 973-751-1600
NY 212-751-1600
FAX 973-751-4931
WWW.NATLTG.COM



PHOTOMETRICS

OBLIQUE 2X2 LED-LO

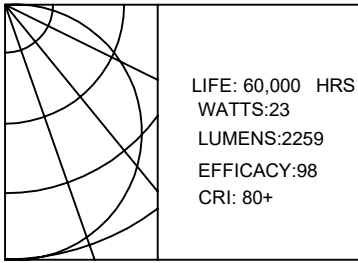

OBLIQUE 2X2 LED-MO

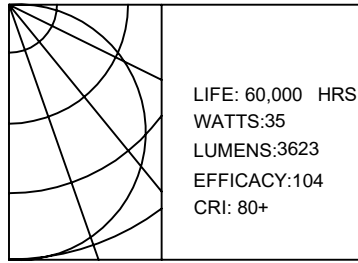

OBLIQUE 2X2 LED-HO

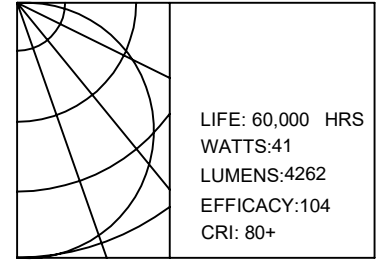

MOUNTING INSTRUCTIONS

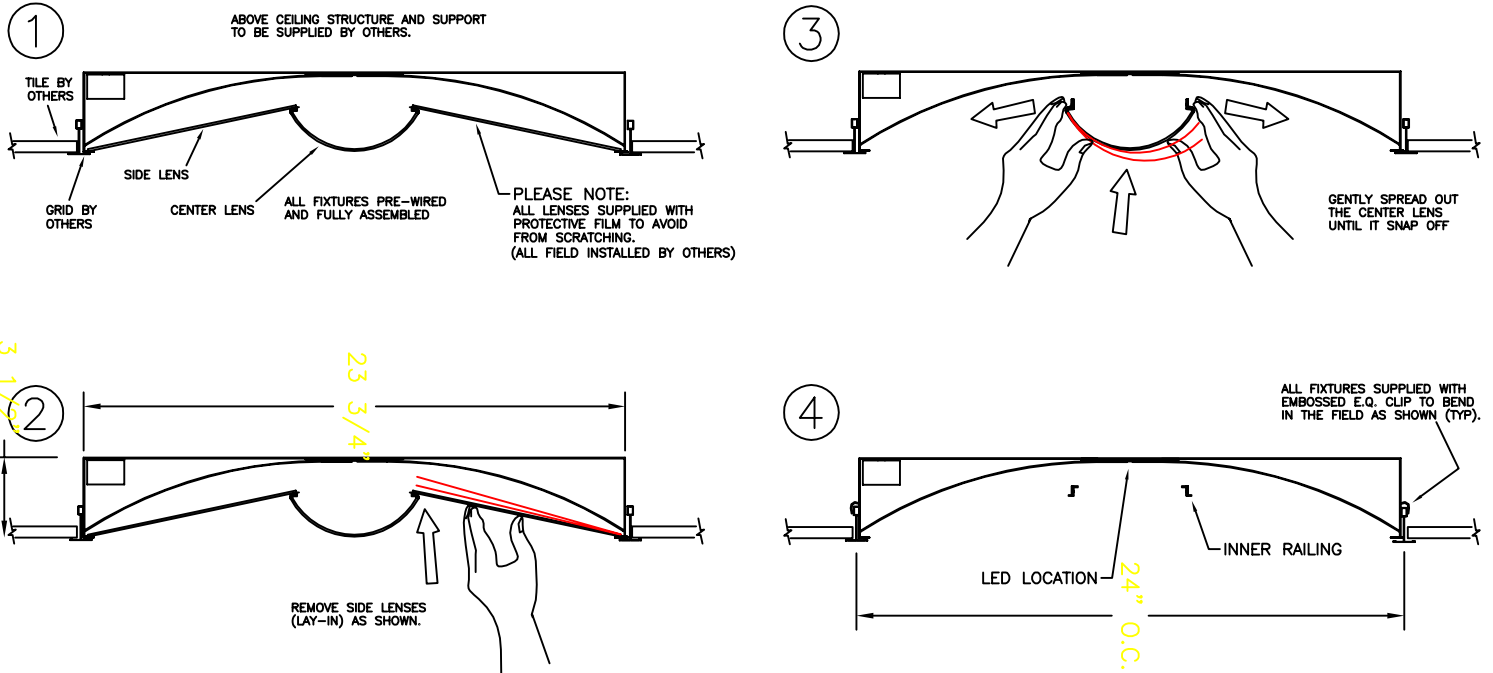

LIGHTING CONTROL SOLUTIONS

- DIMMING (0-10V, DALI Or Lutron)**
 - 0-10V Dimming Driver used as standard.
 - Continuous Dimming up to 10%.
 - Dimming wires not provided unless specified
 - Contact National for Dali or Lutron Control system
- Occ/DAYLIGHT/Vacancy/Bi-Level**
 - Sensor-ready and compatible drivers provided.
 - Sensors can be field installed or could be installed in the fixtures
 - Bi-level dimming and Motion sensors also available
- Compatibility:**

National fixtures are compatible with Lutron, Philips Actilume, Magnum, Wattstopper, Hubbell , Leviton , Hytronik , Daintree & Enlighted Control System

GREENFIELD OPTIONS

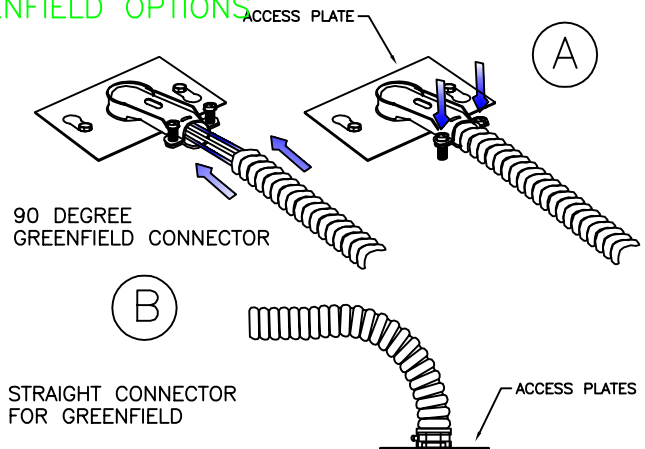

NATIONAL LIGHTING COMPANY, INC.
522 CORTLANDT ST.
BELLEVILLE, NJ 07109

NJ 973-751-1600
NY 212-751-1600
FAX 973-751-4931
WWW.NATLTG.COM

JOB NAME:
CATALOG:
TYPE: