

# NICHE 2NS LED

## HOUSING

THE 5" INCH NOMINAL DEEP HSG TO BE FORMED FROM EXTRUDED ALUMINUM 6063T5 (STANDARD) ALL FIXTURES ARE PRE-WIRED. ALL STEEL PARTS ARE PHOSPHATE TREATED FOR CORROSION RESISTANCE BEFORE PAINT PROCEDURE, THEN BAKED WITH SUPERIOR ADHESION FOR DURABILITY.

## LED MODULES

HIGHER EFFICACY UP TO 170 LPW WITH SERVICE LIFE GREATER THAN 60000(L70) HIGH COLOR RENDER AND EXCELLENT COLOR CONSISTENCY COLOR OPTIONS AVAILABLE FROM 27K TO 40K . 90 CRI LEDS AVAILABLE AS OPTIONAL

## DRIVERS

CONSTANT CURRENT, CLASS 2 UNIVERSAL INPUT : 120-277VAC SOUND RATED A, 54V OUTPUT 0-10V DIMMING STANDARD . DALI, ECOSYSTEM AND DMX DRIVERS ALSO AVAILABLE

## REFLECTOR

TO BE FORMED FROM 20-24GA ALUMINUM FINISH: BAKED WHITE ENAMEL WITH 90% REFLECTIVITY

## MOUNTING

SURFACE, CABLE, PENDANT OR WALL MOUNT

## PRODUCT DESCRIPTION

THE 2NS LED INSURES EXCELLENT FINISH, AND LONG CONTINUOUS UNINTERRUPTED ROWS OF FIXTURES WHILE KEEPING HOUSING DIFFUSION ACCURATE. THE ADVANCED DESIGN OF THE LED 2NS OFFERS HIGH EFFICIENCY AND A MINIMUM OF 60,000 HOURS OF LAMP LIFE, EXCELLENT COLOR AND CONTINUOUS UNINTERRUPTED DIRECT LINE. SURFACE, PENDANT AND WALL MOUNTED FIXTURES ARE AVAILABLE. SNAP ON EXTRUDED FROSTED DIFFUSER CREATE SOFT, EVEN LIGHT.

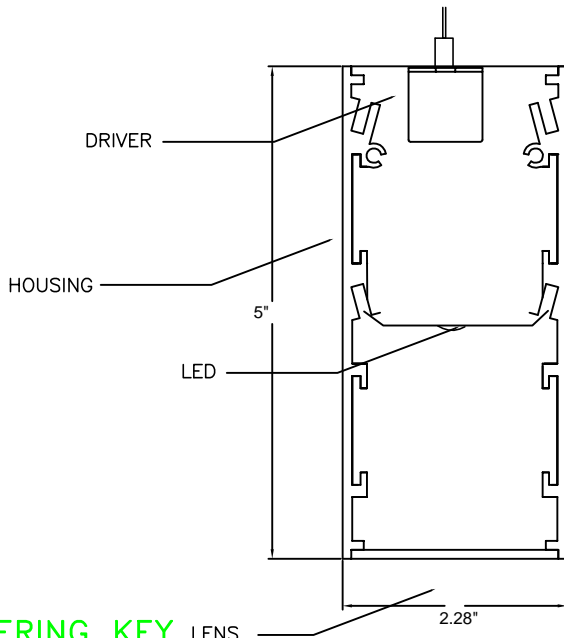
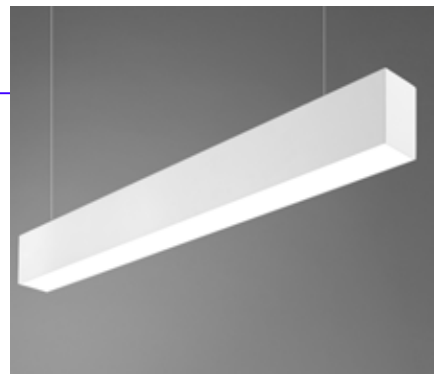

## ORDERING KEY

SERIES	LUMENS/ft (W/ft)	LENGTH	COLOR TEMP	MOUNTING	VOLTAGE	OPTIONS
NICHE 2NS LED (DIRECT)	<input type="checkbox"/> LO 639(5.97) <input type="checkbox"/> MO 894.75(8.9) <input type="checkbox"/> HO 1080(10.5) Please contact National for other options.	<input type="checkbox"/> 2' <input type="checkbox"/> 3' <input type="checkbox"/> 4' <input type="checkbox"/> 6' <input type="checkbox"/> 8' <input type="checkbox"/> ROWS	<input type="checkbox"/> 2700K <input type="checkbox"/> 3000K <input type="checkbox"/> 3500K <input type="checkbox"/> 4000K <input type="checkbox"/> 5000K	<input type="checkbox"/> SM-SURFACE <input type="checkbox"/> AC - CABLE <input type="checkbox"/> P - STEM <input type="checkbox"/> WM-Wall Mount <input type="checkbox"/> OTHER <small>!!! If suspended , please advise the size of cable or Pendant.</small>	<input type="checkbox"/> 120 V <input type="checkbox"/> 277 V <input type="checkbox"/> UNV	<input type="checkbox"/> EM <input type="checkbox"/> DIM 0-10 <input type="checkbox"/> DALI <input type="checkbox"/> Hilume 1%2 Wire-LTEA2W <input type="checkbox"/> Hilume 1% Eco-LDE1 <input type="checkbox"/> Hilume 5% LDE5

LUMENS WILL VARY DEPENDING ON DIFFUSER AND LED COLOR TEMP.

NATIONAL 3ELED SERIES USES ENGINE/STICK ORIGINAL EQUIPMENT (BY OSRAM, PHILIPS, SAMSUNG, ET AL) WHICH ARE RATED FOR APPROXIMATELY 150 LM/WT. ARCHITECTURAL LENSES PROVIDED WITH THE LUMINAIRE BY DESIGN EVEN THE BRIGHTNESS AND VISUAL COMFORT AND MIGHT FRACTIONALLY LOWER LMWT.

## TYPE:

## PROJECT:

EVEN AND VISUALLY COMFORTABLE LED LIGHT DISTRIBUTION ACROSS PROFILE OF THE PRODUCT

50% ENERGY SAVINGS COMPARED TO LINEAR FLUORESCENT

SUSTAINABLE MATERIALS

ARRAY OF LUMEN OPTIONS ALL LM79/LM80 UL APPROVED

5 YEAR WARRANTY LED AND DRIVER

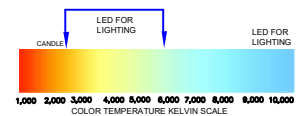

522 CORTLANDT ST.  
BELLEVILLE, NJ 07109

NJ 973-751-1600  
NY 212-751-1600  
FAX 973-751-4931  
WWW.NATLTG.COM

Modules and drivers are UL recognized components and RoHS compliant. LED modules also comply with IENSA LM-79 and LM-80 standards.



# PHOTOMETRIC REPORT

## 2NS LED-LO

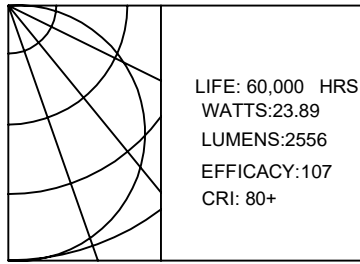

## 2NS LED-MO

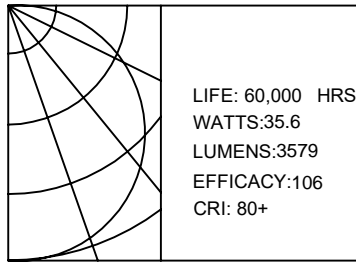

## 2NS LED-HO

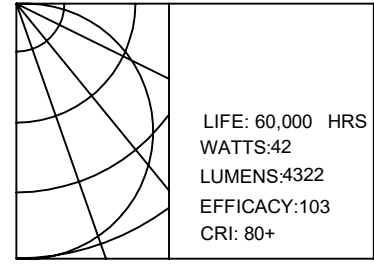

All values are based on 4' Section.

# INSTALLATION INSTRUCTIONS

ABOVE STRUCTURAL SUPPORT TO BE SUPPLIED BY OTHERS.

SURFACE

1

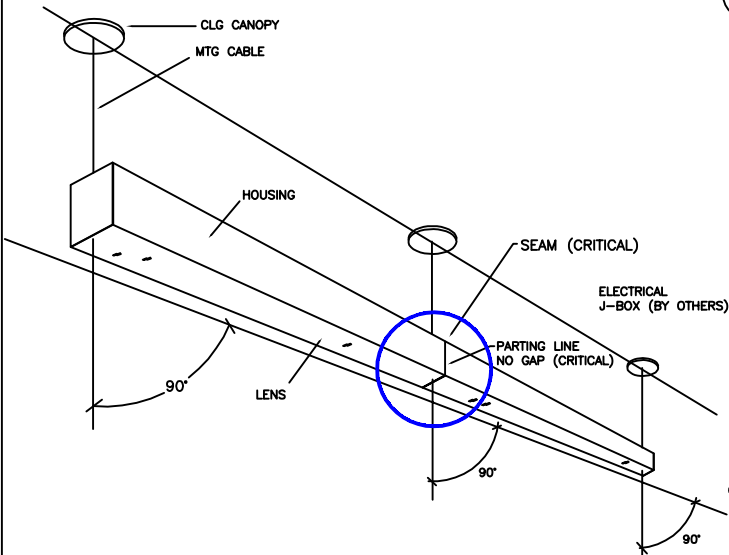

CAUTION! DO NOT ASSEMBLE FIXTURES FROM THE FLOOR!

2

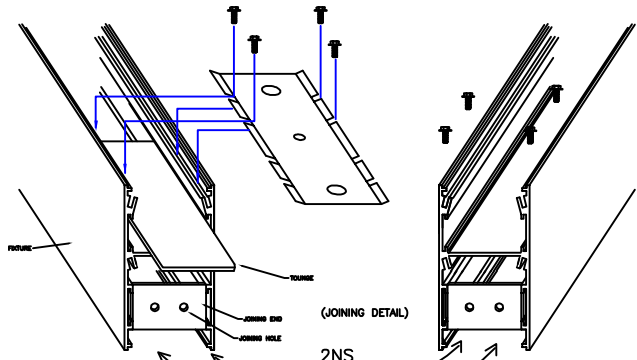
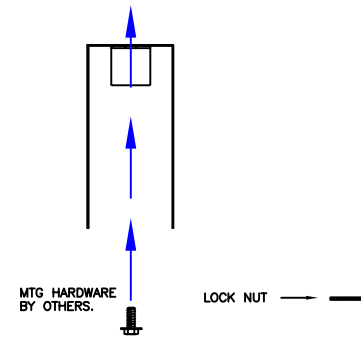

3

# LIGHTING CONTROL SOLUTIONS

- DIMMING ( 0-10V, DALI Or Lutron )**
  - 0-10V Dimming Driver used as standard.
  - Continuous Dimming up to 10%.
  - Dimming wires not provided unless specified
  - Contact National for Dali or Lutron Control system
- Occ/DAYLIGHT/Vacancy/Bi-Level**
  - Sensor-ready and compatible drivers provided.
  - Sensors can be field installed or could be installed in the fixtures
  - Bi-level dimming and Motion sensors also available
- Compatibility:**

National fixtures are compatible with Lutron, Philips Actilume, Magnum, Wattstopper, Hubbell , Leviton , Hytronik , Daintree & Enlighted Control System

# APPLICATION PICTURE



NATIONAL LIGHTING COMPANY, INC.  
522 CORTLANDT ST.  
BELLEVILLE, NJ 07109

NJ 973-751-1600  
NY 212-751-1600  
FAX 973-751-4931  
WWW.NATLTC.COM

JOB NAME:
CATALOG:
TYPE: