

ENLIGHTEN 2x4 LED

HOUSING

TO BE FORMED FROM 20GA CRS
FINISH: ECO WHITE (STANDARD)
ALL STEEL PARTS ARE PHOSPHATE
TREATED FOR CORROSION RESISTANCE
BEFORE PAINT PROCEDURE, THEN
BAKED WITH SUPERIOR ADHESION
FOR DURABILITY

LED MODULES

HIGHER EFFICACY UP TO 170 LPW
WITH SERVICE LIFE GREATER THAN
60000(L70) HIGH COLOR RENDER AND
EXCELLENT COLOR CONSISTENCY
COLOR OPTIONS AVAILABLE FROM
27K TO 40K .
90 CRI LEDS AVAILABLE AS OPTIONAL

REFLECTOR

TO BE FORMED FROM 20GA CRS
FINISH: BAKED WHITE ENAMEL WITH
90% REFLECTIVITY

MOUNTING

FLANGE, SLOT GRID
FLANGELESS, 15/16 GRID(T)
1/6 GRID(T1)

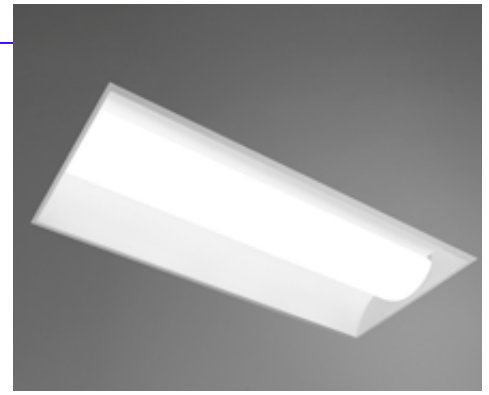

PRODUCT DESCRIPTION

THE ENLIGHTEN'S SCULPTURED CURVED INTERIOR AND
MATCHING PROFILE LENS EVENLY ILLUMINATES THE ENTIRE
FIXTURE APERTURE. THE HIGHLY REFLECTIVE CONTOURED
REFLECTOR AND HIGH LIGHT TRANSMISSION OF THE
LINEAR PRISMATIC DIFFUSER, ENCLOSE THE LED AND
DISTRIBUTE LIGHT EVENLY THROUGH THE SPACE. HIGH
EFFICIENCY, LONG LIFE, EXCELLENT COLOR MAKE THE
ENLIGHTEN IDEAL FOR OFFICES, SCHOOLS, RETAIL
LOCATIONS AND MEDICAL.

TYPE:

CONSTANT CURRENT, CLASS 2
UNIVERSAL INPUT : 120-277VAC
SOUND RATED A, 54V OUTPUT 0-10V
DIMMING STANDARD .
DALI, ECOSYSTEM AND DMX DRIVERS
ALSO AVAILABLE

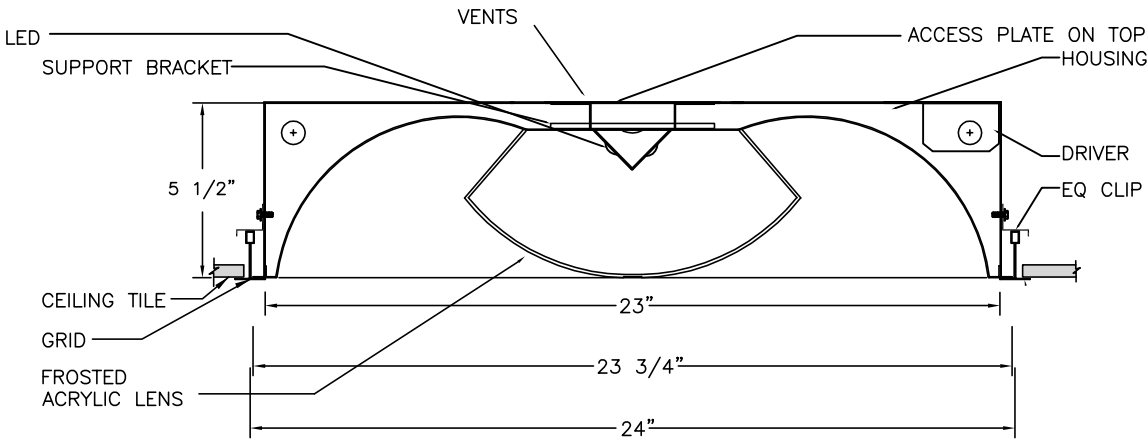

PROJECT:

EVEN AND VISUALLY
COMFORTABLE LED
LIGHT DISTRIBUTION
ACROSS PROFILE OF
THE PRODUCT

50% ENERGY
SAVINGS COMPARED
TO LINEAR
FLUORESCENT

SUSTAINABLE
MATERIALS

ARRAY OF LUMEN
OPTIONS ALL
LM79/LM80 UL
APPROVED

5 YEAR WARRANTY
LED AND DRIVER

CEILING OPTIONS

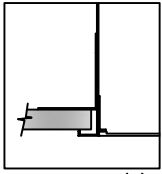

FLANGE (F)

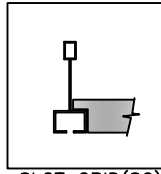

SLOT GRID (SG)

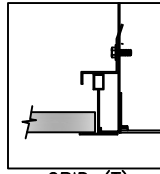

GRID (T)

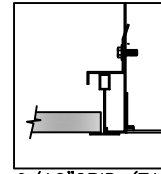

9/16" GRID (T1)

ORDERING KEY

SERIES	LUMENS / (W)	COLOR TEMP	CEILING TYPE	VOLTAGE	OPTIONS
ENLIGHTEN2X4LED	<input type="checkbox"/> 3169(36) <input type="checkbox"/> 5228(51) <input type="checkbox"/> 6654(62) Please contact National for other options.	<input type="checkbox"/> 2700K <input type="checkbox"/> 3000K <input type="checkbox"/> 3500K <input type="checkbox"/> 4000K <input type="checkbox"/> 5000K	<input type="checkbox"/> T <input type="checkbox"/> F <input type="checkbox"/> SG <input type="checkbox"/> T1	<input type="checkbox"/> 120 V <input type="checkbox"/> 277 V <input type="checkbox"/> UNIVERSAL	<input type="checkbox"/> EM <input type="checkbox"/> DIM 0-10 <input type="checkbox"/> DALI <input type="checkbox"/> HiLume 1% 2 Wire-LTEA2W <input type="checkbox"/> HiLume 1% Eco-LDE1 <input type="checkbox"/> HiLume 5% LDE5

LUMENS WILL VARY
DEPENDING ON DIFFUSER
AND LED COLOR TEMP.

NATIONAL 3E/LED SERIES USES ENGINE/STICK ORIGINAL EQUIPMENT (BY OSRAM, PHILIPS, SAMSUNG, ET AL) WHICH ARE RATED FOR APPROXIMATELY 100 LM/W. ARCHITECTURAL LENSES PROVIDED WITH THE LUMINAIRES BY DESIGN EVEN THE BRIGHTNESS AND VISUAL COMFORT AND MIGHT FRACTIONALLY LOWER LM/W.

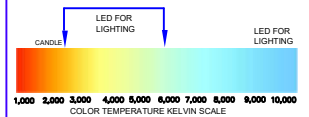

522 CORTLANDT ST.
BELLEVILLE, NJ 07109

NJ 973-751-1600
NY 212-751-1600
FAX 973-751-4931
WWW.NATLTG.COM



PHOTOMETRICS

ENLIGHTEN 24 LED-LO

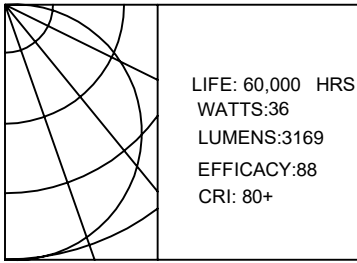

ENLIGHTEN 24 LED-MO

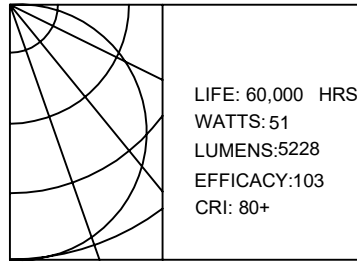

ENLIGHTEN 24 LED-HO

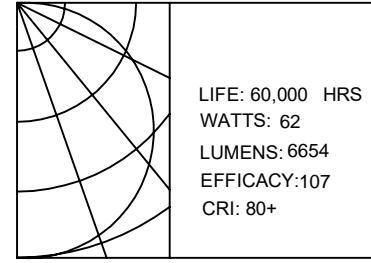

MOUNTING INSTRUCTIONS

ABOVE STRUCTURAL SUPPORT TO BE SUPPLIED BY OTHERS.

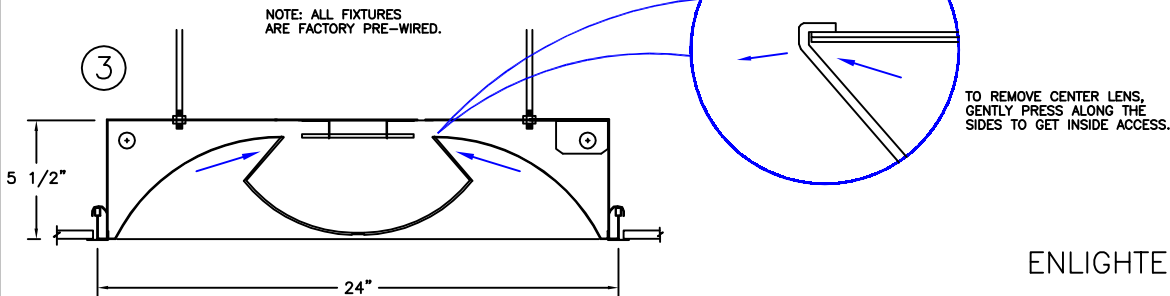
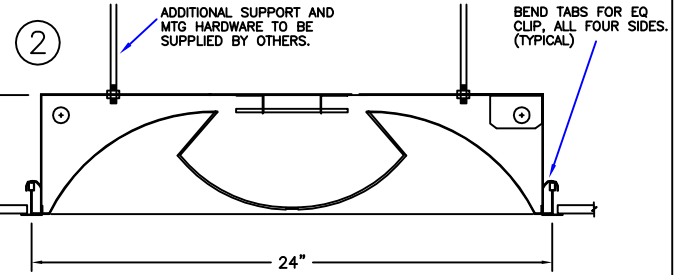
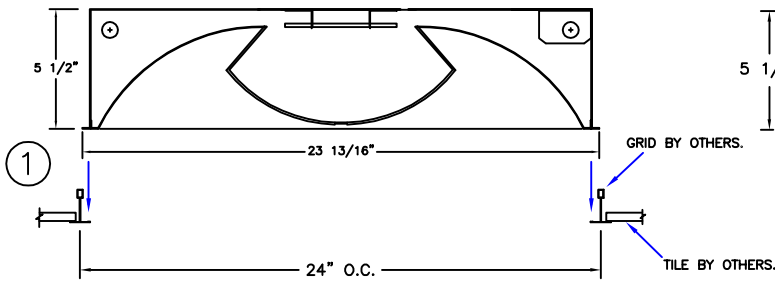

ENLIGHTEN 2X2 SERIES

LIGHTING CONTROL SOLUTIONS

- DIMMING (0-10V, DALI Or Lutron)**
 - 0-10V Dimming Driver used as standard.
 - Continuous Dimming up to 10%.
 - Dimming wires not provided unless specified
 - Contact National for Dali or Lutron Control system
- Occ/DAYLIGHT/Vacancy/Bi-Level**
 - Sensor-ready and compatible drivers provided.
 - Sensors can be field installed or could be installed in the fixtures
 - Bi-level dimming and Motion sensors also available
- Compatibility:**

National fixtures are compatible with Lutron, Philips Actilume, Magnum, Wattstopper, Hubbell , Leviton , Hytronik , Daintree & Enlighted Control System

GREENFIELD OPTIONS

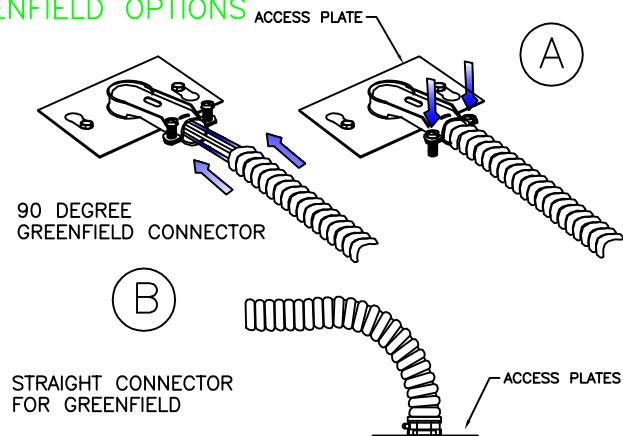

NATIONAL LIGHTING COMPANY, INC.
522 CORTLANDT ST.
BELLEVILLE, NJ 07109

NJ 973-751-1600
NY 212-751-1600
FAX 973-751-4931
WWW.NATLTG.COM

JOB NAME:	
CATALOG:	
TYPE:	