

DTF LED

HOUSING

FORMED FROM FIBERGLASS W/ STEEL INTERNAL
FIBER GLASS UNIT IS IP APPROVED AND SEALED
COMES WITH 6-LATCHES IP65 RATED

LENS

INLINE THERMAL-FORMED LENS TAPERED HIGH
DIFFUSION ACRYLIC PRISMATIC ES WITH 6-LATCHES
IP65 RATED

LED MODULES

HIGHER EFFICACY UP TO 170 LPW
WITH SERVICE LIFE GREATER THAN
60000(L70) HIGH COLOR RENDITION AND
EXCELLENT COLOR CONSISTENCY
COLOR OPTIONS AVAILABLE FROM
27K TO 40K .
90 CRI LEDS AVAILABLE AS OPTIONAL

MOUNTING

SURFACE,PENDANT, CABLE AND
WALL MOUNT

DRIVERS

CONSTANT CURRENT, CLASS 2
UNIVERSAL INPUT : 120-277VAC
SOUND RATED A, 54V OUTPUT 0-10V
DIMMING STANDARD .
DALI, ECOSYSTEM AND DMX DRIVERS
ALSO AVAILABLE



PRODUCT DESCRIPTION

THE DTF IS IDEAL FOR GARAGES, OUTDOOR USE AS WELL AS
INDOOR INSTALLATIONS, WALL, CEILING OR SUSPENDED
APPLICATIONS. THE HOUSING IS ONE PIECE, MOLDED
FIBERGLASS, REINFORCED POLYESTER. THERE WILL BE NO
CORROSION, OXIDATION OR RUSTING

TYPE:

PROJECT:

EVEN AND VISUALLY
COMFORTABLE LED
LIGHT DISTRIBUTION
ACROSS PROFILE OF
THE PRODUCT

50% ENERGY
SAVINGS COMPARED
TO LINEAR
FLUORESCENT

SUSTAINABLE
MATERIALS

ARRAY OF LUMEN
OPTIONS ALL
LM79/LM80 UL
APPROVED

5 YEAR WARRANTY
LED AND DRIVER

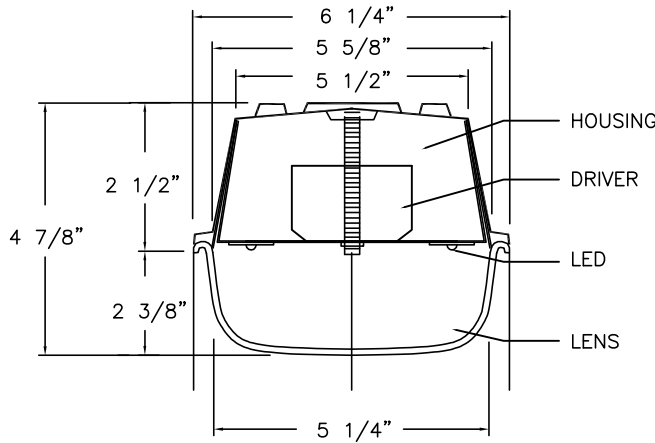

ORDERING KEY

SERIES	LUMENS/ft (W/ft)	LENGTH	COLOR TEMP	MOUNTING	VOLTAGE	OPTIONS
DTF LED	<input type="checkbox"/> LO 851.5(31)	<input type="checkbox"/> 4'	<input type="checkbox"/> 2700K	<input type="checkbox"/> SM - SURFACE	<input type="checkbox"/> 120 V	<input type="checkbox"/> EM
	<input type="checkbox"/> MO 1150.5(10.57)	<input type="checkbox"/> 8'	<input type="checkbox"/> 3000K	<input type="checkbox"/> P - STEM	<input type="checkbox"/> 277 V	<input type="checkbox"/> DIM 0-10
	<input type="checkbox"/> HO 1518(14.25)		<input type="checkbox"/> 3500K	<input type="checkbox"/> 24"	<input type="checkbox"/> UNIVERSAL	<input type="checkbox"/> DALI
			<input type="checkbox"/> 4000K	<input type="checkbox"/> 48"		<input type="checkbox"/> HiLume 1%LTEA2W
			<input type="checkbox"/> 5000K	<input type="checkbox"/> OTHER _____		<input type="checkbox"/> HiLume 1% Eco-LDE1
						<input type="checkbox"/> LEXAN

LUMENS WILL VARY
DEPENDING ON DIFFUSER
AND LED COLOR TEMP.

NATIONAL 3E LED SERIES USES ENGINE/STICK ORIGINAL EQUIPMENT (BY OSRAM, PHILIPS, SAMSUNG, ET AL) WHICH ARE RATED FOR APPROXIMATELY 100 LM/W. ARCHITECTURAL LENSES PROVIDED WITH THE LUMINAIRES BY DESIGN EVEN THE BRIGHTNESS AND VISUAL COMFORT AND MIGHT FRACTIONALLY LOWER LM/W.

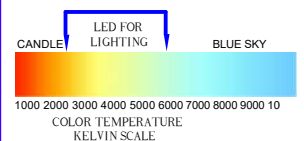

522 CORTLANDT ST.
BELLEVILLE, NJ 07109

NJ 973-751-1600
NY 212-751-1600
FAX 973-751-4931
WWW.NATLTG.COM

Modules and drivers are UL recognized
components and RoHS compliant.
LED modules also comply with IENSA
LM-79 and LM-80 standards.



PHOTOMETRIC REPORT

DTF LED-LO

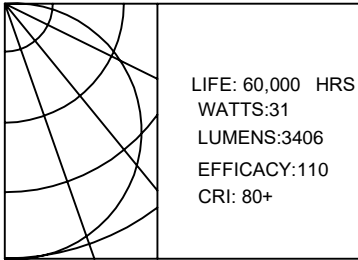

DTF LED-MO

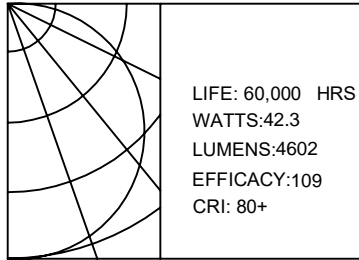

DTF-LED-HO

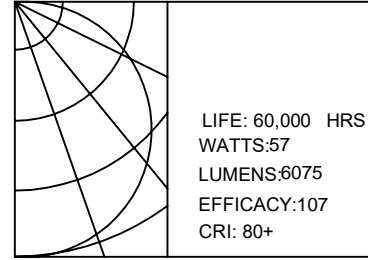

All values are based on 4' Section.

INSTALLATION INSTRUCTIONS

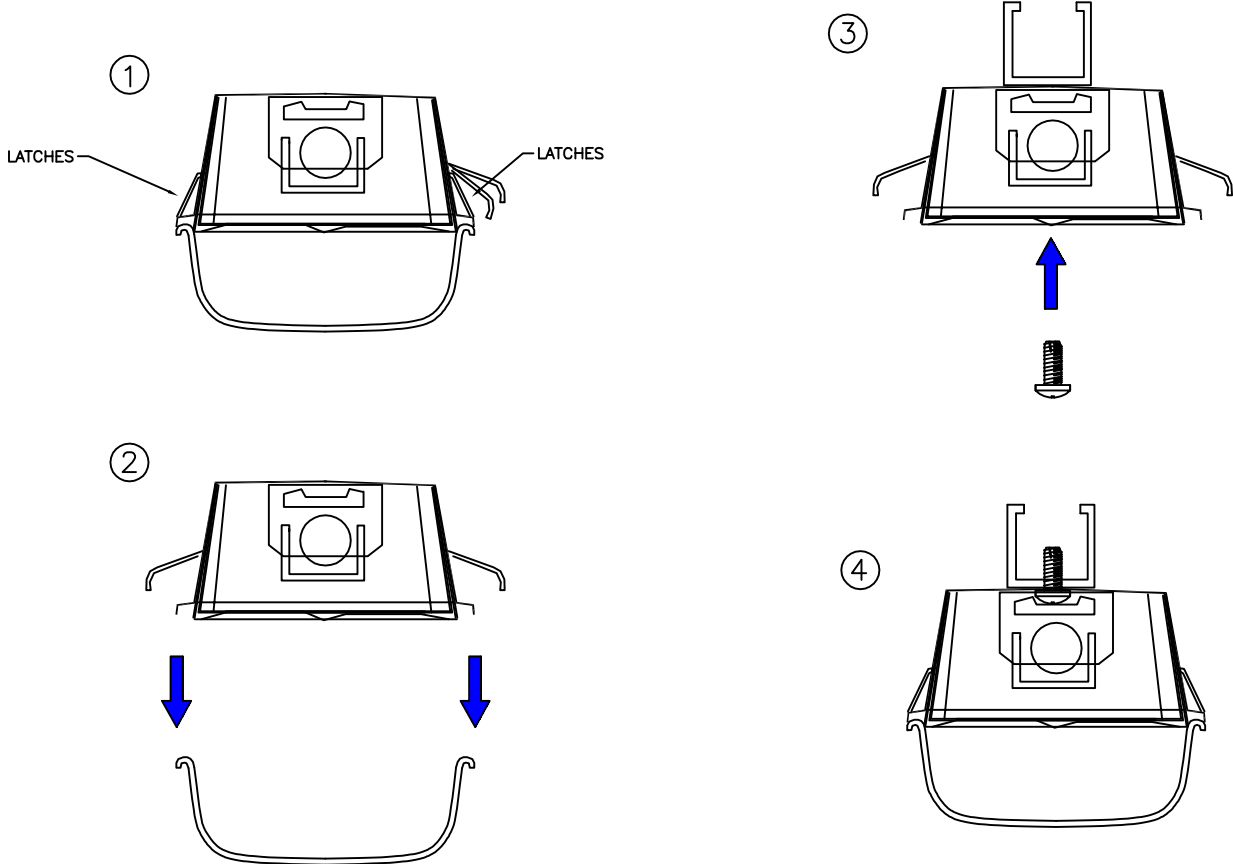

LIGHTING CONTROL SOLUTIONS

- DIMMING (0-10V, DALI Or Lutron)**
 - 0-10V Dimming Driver used as standard.
 - Continuous Dimming up to 10%.
 - Dimming wires not provided unless specified
 - Contact National for Dali or Lutron Control system
- Occ/DAYLIGHT/Vacancy/Bi-Level**
 - Sensor-ready and compatible drivers provided.
 - Sensors can be field installed or could be installed in the fixtures
 - Bi-level dimming and Motion sensors also available
- Compatibility:**

National fixtures are compatible with Lutron, Philips Actilume, Magnum, Wattstopper, Hubbell , Leviton , Hytronik , Daintree & Enlighted Control System

TYPICAL BACK PLAN

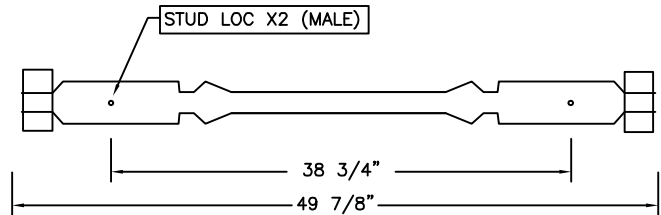

NATIONAL LIGHTING
COMPANY, INC.
522 CORTLANDT ST.
BELLEVILLE, NJ 07109

NJ 973-751-1600
NY 212-751-1600
FAX 973-751-4931
WWW.NATLTC.COM

JOB NAME:
CATALOG:
TYPE: