

AFFINE 1x4 LED

HOUSING

TO BE FORMED FROM 20GA CRS
FINISH: ECO WHITE (STANDARD)
ALL STEEL PARTS ARE PHOSPHATE
TREATED FOR CORROSION RESISTANCE
BEFORE PAINT PROCEDURE, THEN
BAKED WITH SUPERIOR ADHESION
FOR DURABILITY

LED MODULES

HIGHER EFFICACY UP TO 170 LPW
WITH SERVICE LIFE GREATER THAN
60000(L70) HIGH COLOR RENDER AND
EXCELLENT COLOR CONSISTENCY
COLOR OPTIONS AVAILABLE FROM
27K TO 40K .
90 CRI LEDS AVAILABLE AS OPTIONAL

DRIVERS

CONSTANT CURRENT, CLASS 2
UNIVERSAL INPUT : 120-277VAC
SOUND RATED A, 54V OUTPUT 0-10V
DIMMING STANDARD .
DALI, ECOSYSTEM AND DMX DRIVERS
ALSO AVAILABLE

REFLECTOR

TO BE FORMED FROM 20GA CRS
FINISH: BAKED WHITE ENAMEL WITH
90% REFLECTIVITY

MOUNTING

FLANGE, SLOT GRID
FLANGELESS, 1/16" GRID(T)
1/16" GRID(T1)

PRODUCT DESCRIPTION

THE AFFINE LED 1'X4' COMBINES DIGITAL LED LIGHTING WITH
HIGH PERFORMANCE AFFINE OPTICAL DESIGN. THE ADVANCED
DESIGN OF THE LED AFFINE 1'X4' OFFERS HIGH EFFICIENCY,
60000 HRS OF LIFE AND EXCELLENT COLOR FOR GENERAL
AMBIENT LIGHTING APPLICATIONS. THE LINEAR INTEGRAL
PRISMS OF THE TRANSLUCENT LENS DISTRIBUTES LIGHT
EVENLY IN TO THE SPACE, WHILE MINIMIZING CONTRAST
BETWEEN THE FIXTURE AND CEILING .

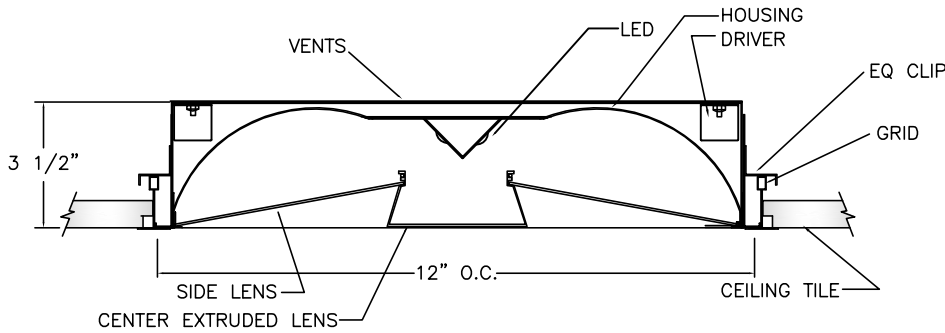
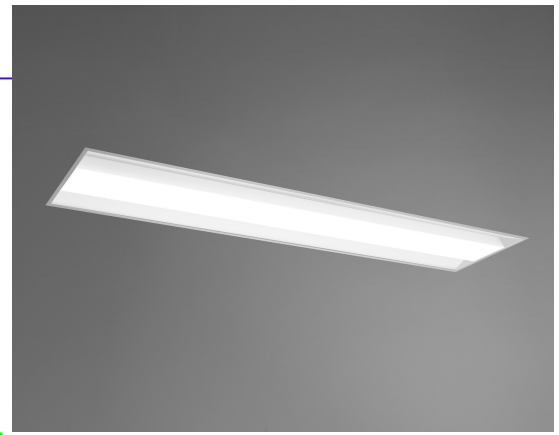

CEILING OPTIONS

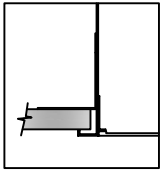

FLANGE(F)

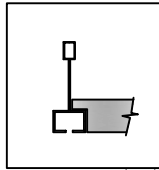

SLOT GRID(SG)

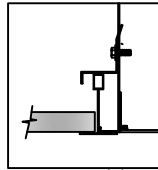

GRID (T)

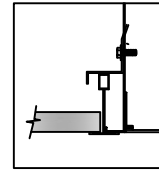

9/16"GRID (T1)

ORDERING KEY

SERIES	LUMENS (WATTS)	COLOR TEMP	CEILING TYPE	VOLTAGE	OPTIONS
AFF14LED	<input type="checkbox"/> 3331(31.24) <input type="checkbox"/> 4098(39.87) <input type="checkbox"/> 4864(48) Please contact National for other options.	<input type="checkbox"/> 2700K* <input type="checkbox"/> 3000K <input type="checkbox"/> 3500K <input type="checkbox"/> 4000K <input type="checkbox"/> 5000K Contact National For 2700K Option	<input type="checkbox"/> T <input type="checkbox"/> F <input type="checkbox"/> SG <input type="checkbox"/> T1	<input type="checkbox"/> 120 V <input type="checkbox"/> 277 V <input type="checkbox"/> UNIVERSAL	<input type="checkbox"/> EM <input type="checkbox"/> 0-10V <input type="checkbox"/> DALI <input type="checkbox"/> EcoSystem, 2 WIRE <input type="checkbox"/> Lutron 3-WIRE <input type="checkbox"/> SENSOR(OCC/VAC) <input type="checkbox"/> WHIPS

LUMENS WILL VARY
DEPENDING ON DIFFUSER
AND LED COLOR TEMP.

NATIONAL 3E/LED SERIES USES ENGINE/STICK ORIGINAL EQUIPMENT (BY OSRAM, PHILIPS, SAMSUNG, ET AL) WHICH ARE RATED FOR APPROXIMATELY 150 LM/W. ARCHITECTURAL LENSES PROVIDED WITH THE LUMINAIRES BY DESIGN EVEN THE BRIGHTNESS AND VISUAL COMFORT AND MIGHT FRACTIONALLY LOWER LM/W.

TYPE:

PROJECT:

EVEN AND VISUALLY
COMFORTABLE LED
LIGHT DISTRIBUTION
ACROSS PROFILE OF
THE PRODUCT

50% ENERGY
SAVINGS COMPARED
TO LINEAR
FLUORESCENT

SUSTAINABLE
MATERIALS

ARRAY OF LUMEN
OPTIONS ALL
LM79/LM80 UL
APPROVED

5 YEAR WARRANTY
LED AND DRIVER



522 CORTLANDT ST.
BELLEVILLE, NJ 07109

NJ 973-751-1600
NY 212-751-1600
FAX 973-751-4931
WWW.NATLTG.COM

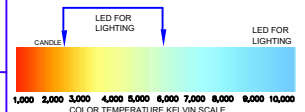

PHOTOMETRICS

AFFINE 14 LED LO

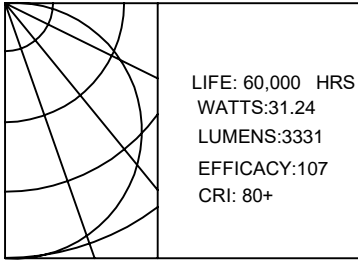

AFFINE 14 LED MO

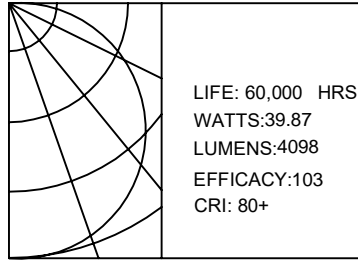

AFFINE 14 LED HO

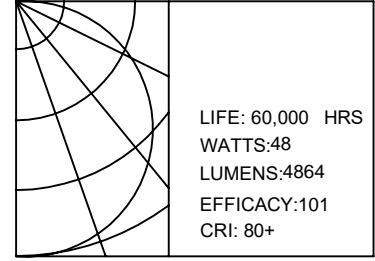

MOUNTING INSTRUCTIONS

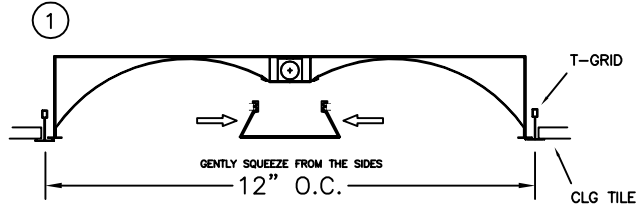

ABOVE CEILING STRUCTURE AND SUPPORT TO BE SUPPLIED BY OTHERS.

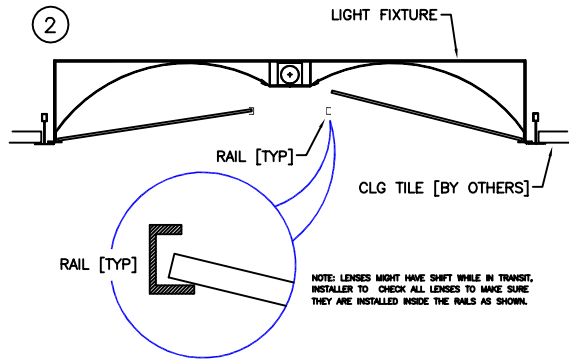

NOTE: ALL PLASTIC SIDE PANELS ARE TO BE FIELD INSTALLED BY OTHERS.

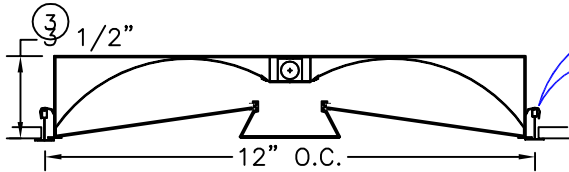
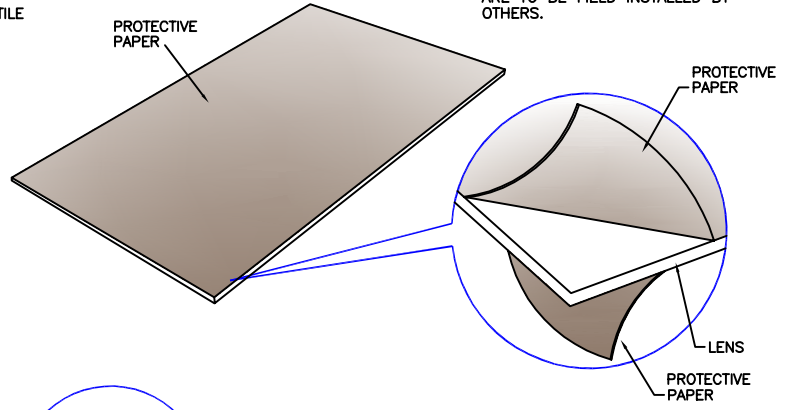

LIGHTING CONTROL SOLUTIONS

- DIMMING (0-10V, DALI Or Lutron)**
 - 0-10V Dimming Driver used as standard.
 - Continuous Dimming up to 10%.
 - Dimming wires not provided unless specified
 - Contact National for Dali or Lutron Control system
- Occ/DAYLIGHT/Vacancy/Bi-Level**
 - Sensor-ready and compatible drivers provided.
 - Sensors can be field installed or could be installed in the fixtures
 - Bi-level dimming and Motion sensors also available
- Compatibility:**

National fixtures are compatible with Lutron, Philips Actilume, Magnum, Wattstopper, Hubbell , Leviton , Hytronik , Daintree & Enlighted Control System

GREENFIELD OPTIONS

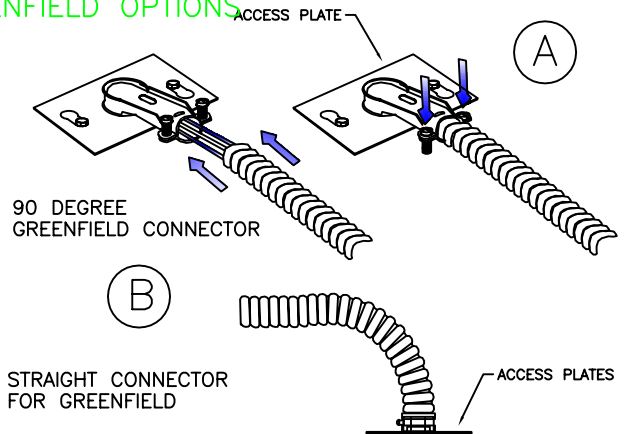

NATIONAL LIGHTING COMPANY, INC.
522 CORTLANDT ST.
BELLEVILLE, NJ 07109

NJ 973-751-1600
NY 212-751-1600
FAX 973-751-4931
WWW.NATLTG.COM

JOB NAME:
CATALOG:
TYPE: